

CP3215-E281

main dimensions and
fixing points

dimensions in mm

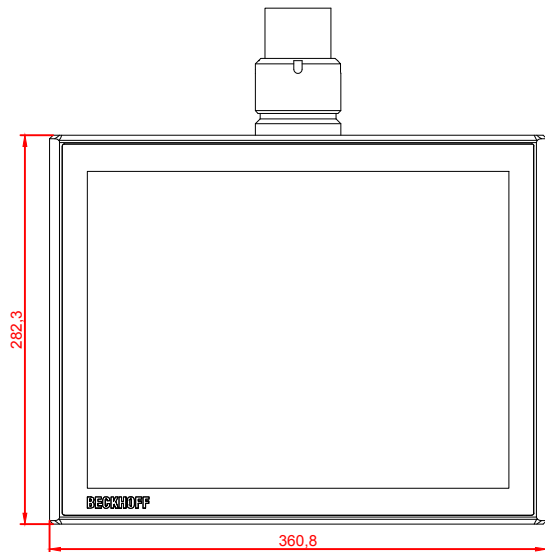

front view

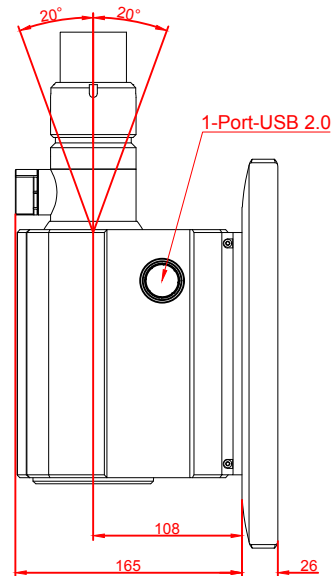

left view

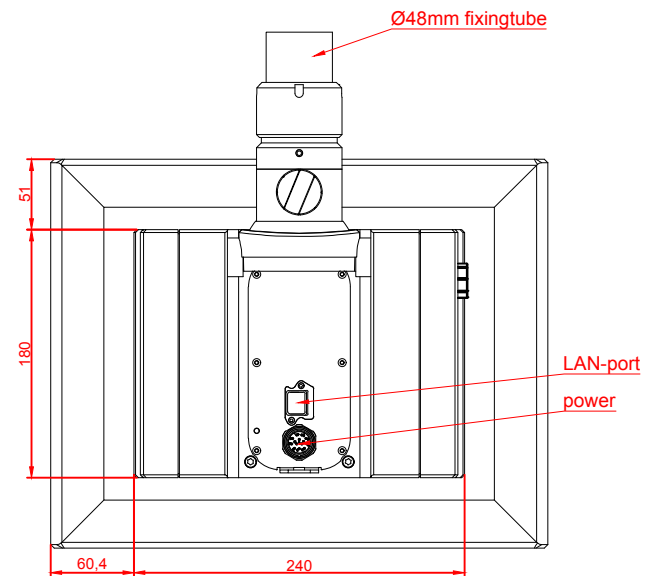

rear view

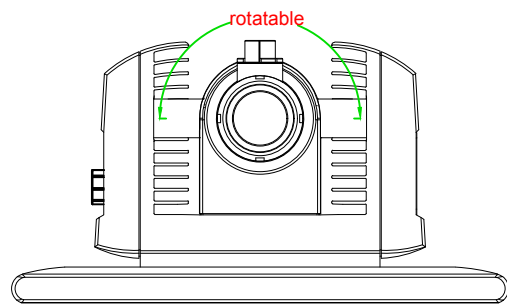

top view

