

CP2711-0010

main dimensions and
fixing points

dimensions in mm

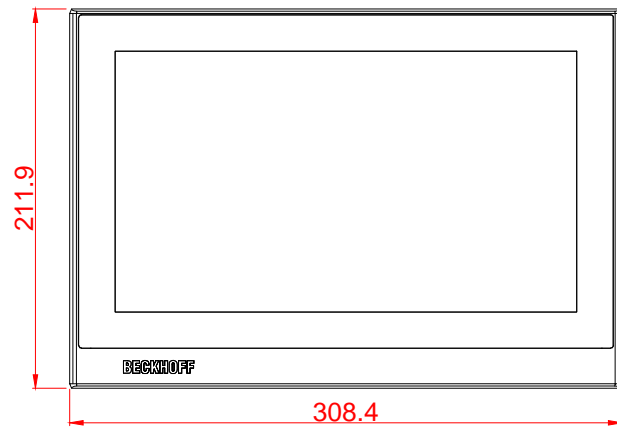

front view

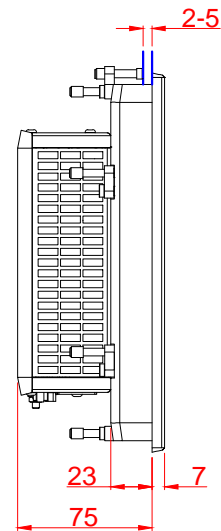

left view

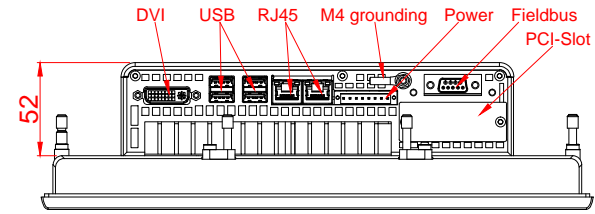

bottom view

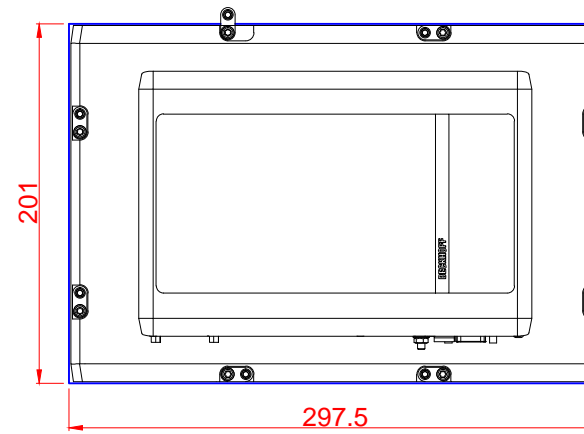

cut out dimensions: 201mm x 297,5mm

rear view

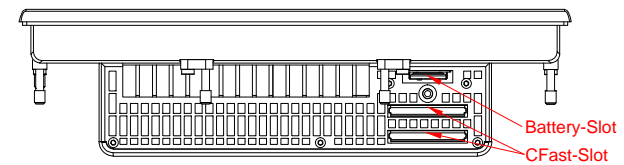

top view