

CP2611

main dimensions and
fixing points

dimensions in mm

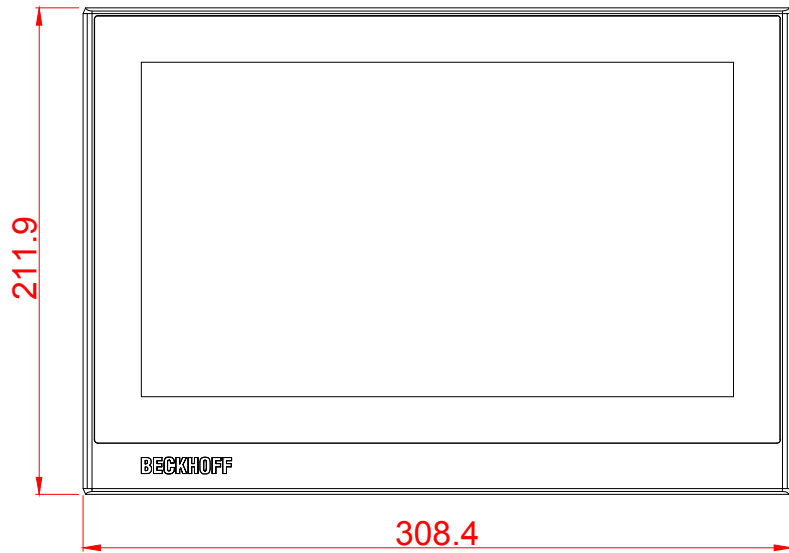

front view

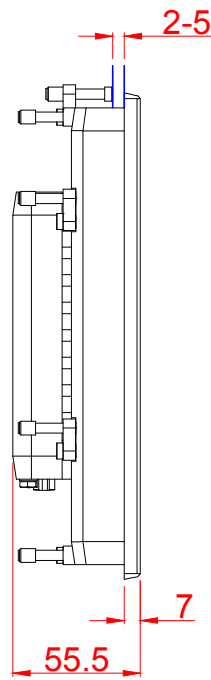

left view

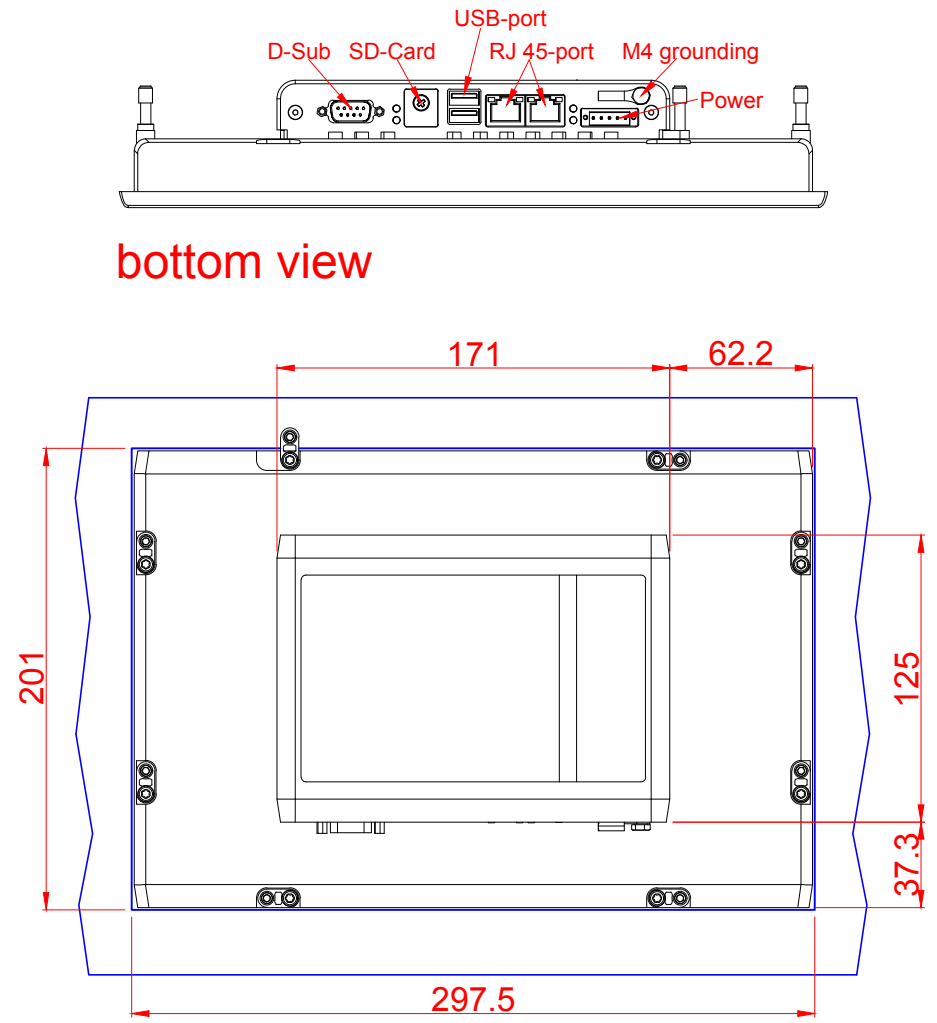

bottom view

cut out dimensions: 201mm x 297,5mm

rear view