

bottom view

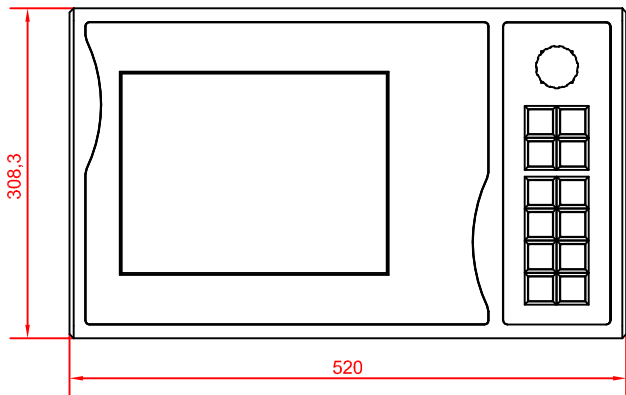

front view

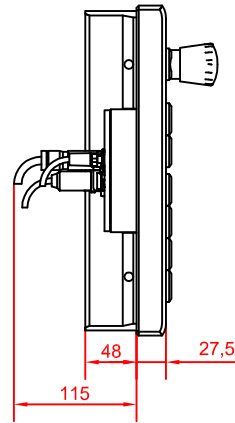

left view

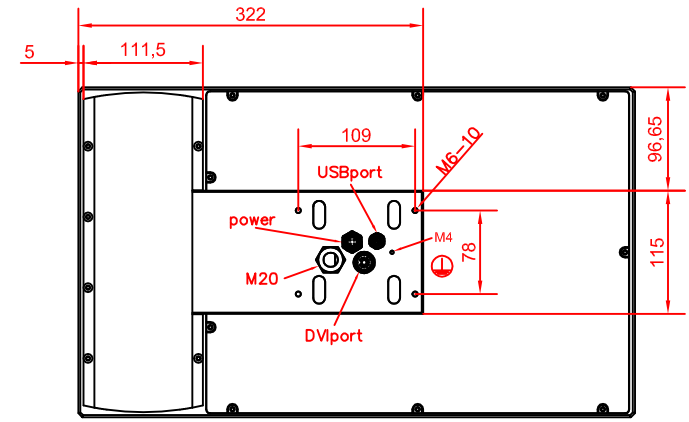

rear view

CP7921-0000-E707
 arm adapter for
 Rolec - Tara - suspension adaption
 146.025.019

main dimensions and
 fixing points

dimensions in mm

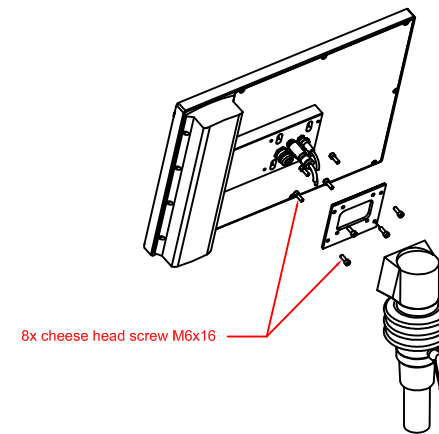

8x cheese head screw M6x16

149.025.013