

bottom view

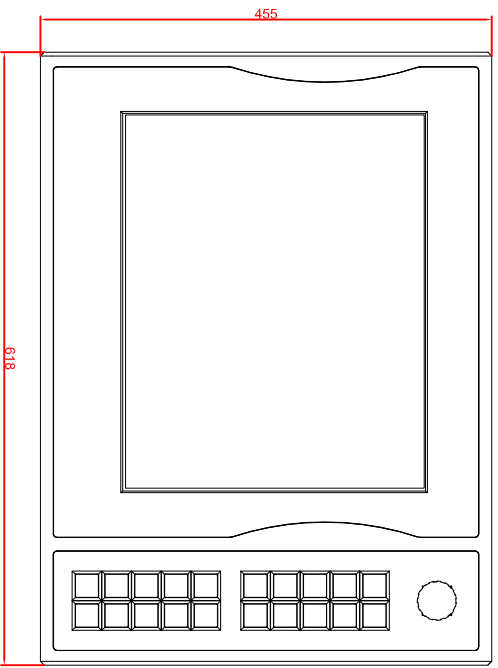

front view

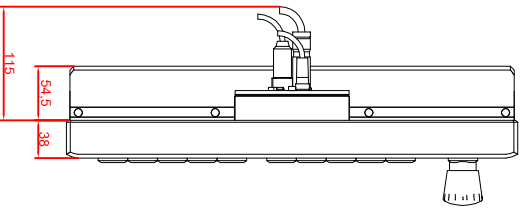

left view

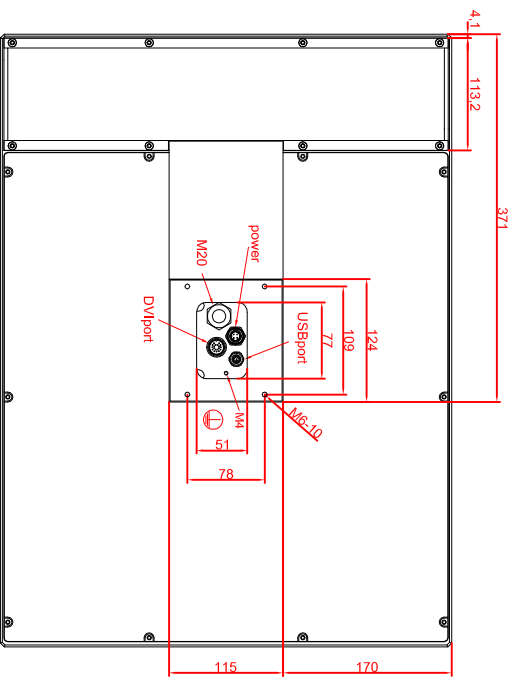

rear view

CP7903-0000-E/28
 arm adapter for
 Roltec - Tara Plus -
 suspension adaption
 main dimensions and
 fixing points
 dimensions in mm

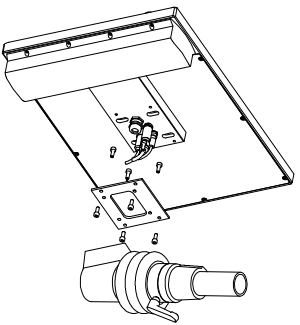

149.025.014

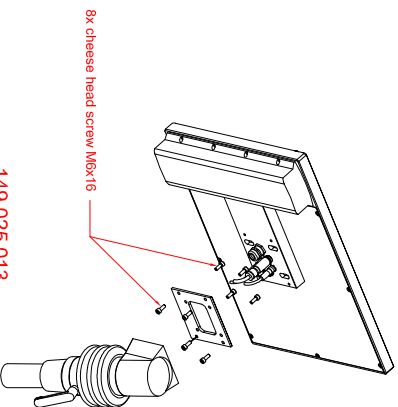

149.025.013