

CP7812-0000-E756  
 arm adapter for  
 Rolec - Tara - suspension adaption  
 146.025.019

main dimensions and  
 fixing points

dimensions in mm

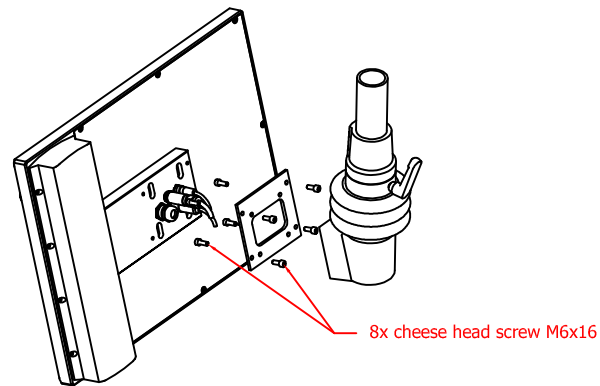

149.025.014