

front view

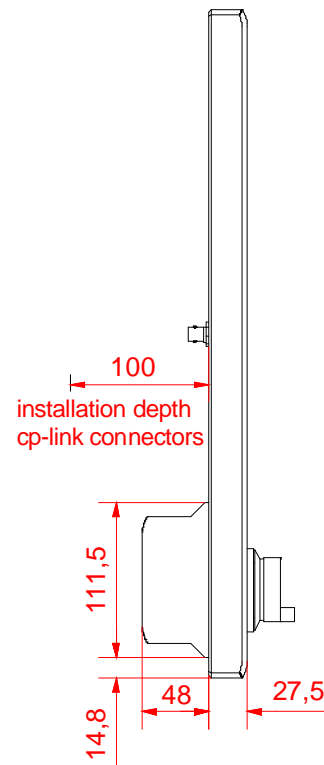

left view

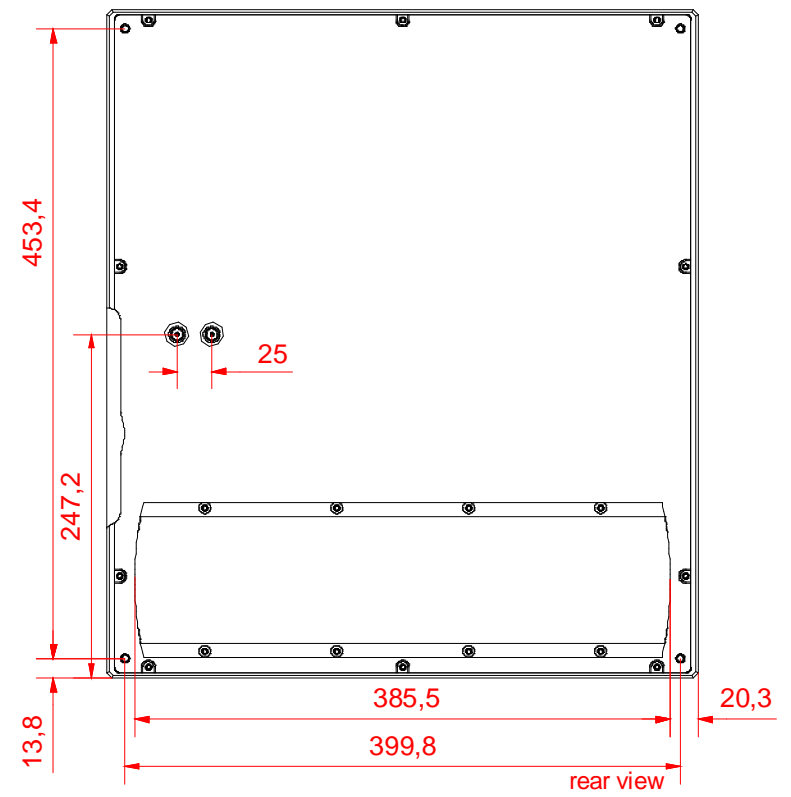

rear view

CP 7037 - 0001 - E630

main dimensions and
fixing points

dimensions in mm

