

bottom view

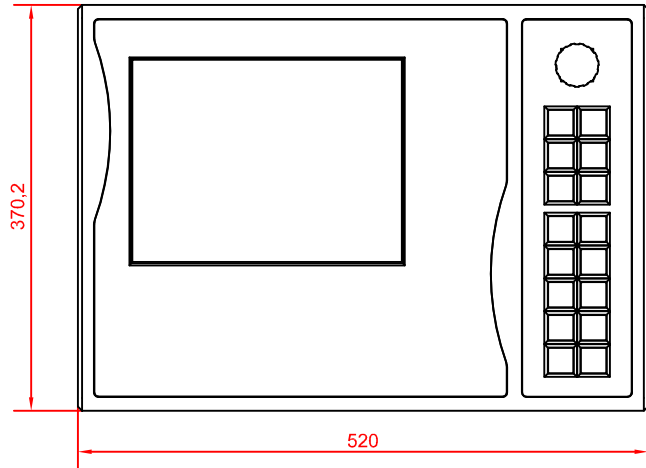

front view

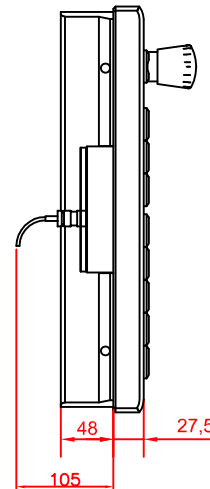

left view

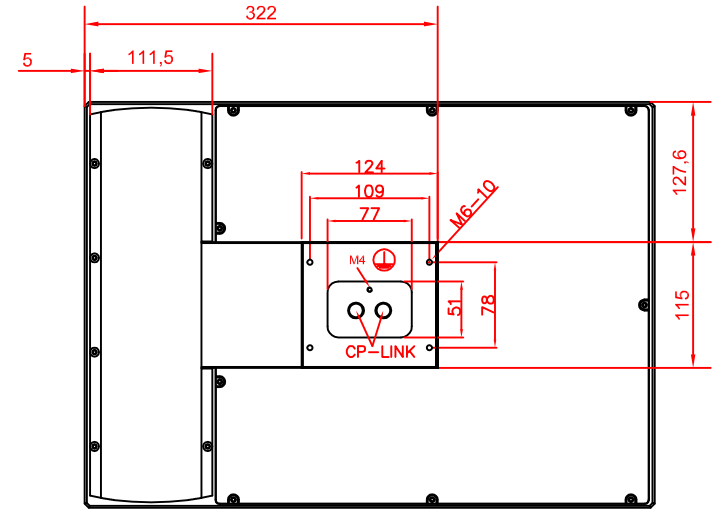

rear view

CP7031-0001-E616  
arm adapter for  
Rolec - Tara - suspension adaption  
146.025.019

main dimensions and  
fixing points

dimensions in mm

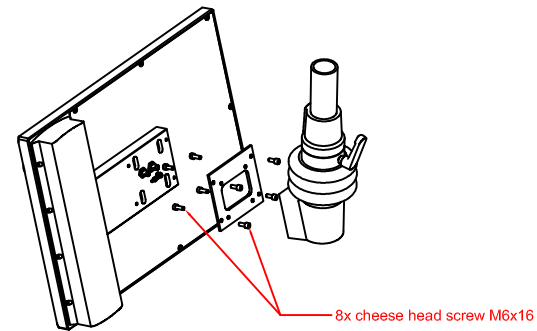

8x cheese head screw M6x16

149.025.014