

bottom view

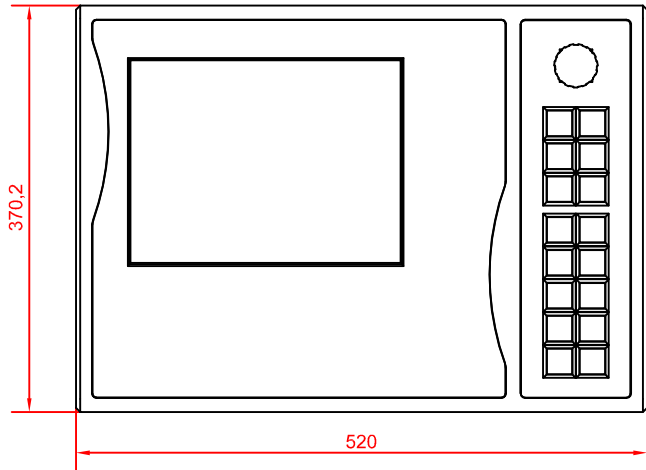

front view

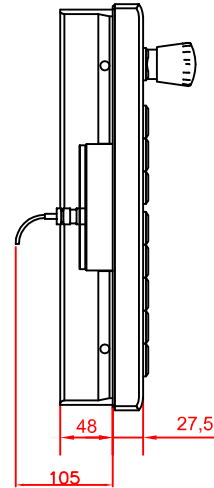

left view

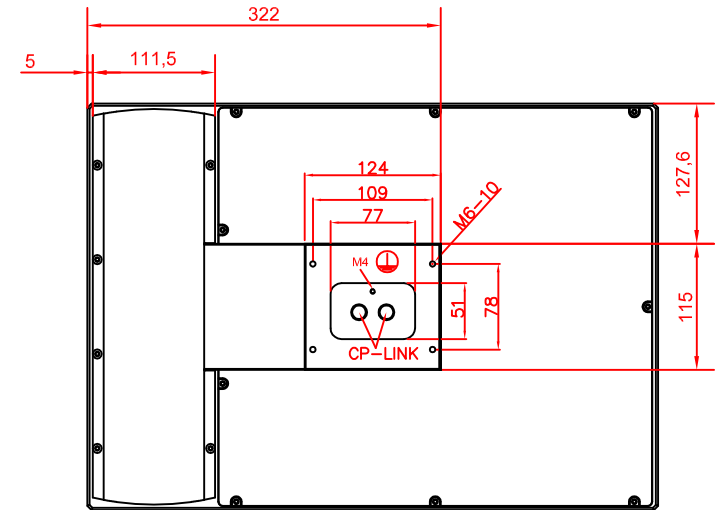

rear view

CP7031-0000-E618
arm adapter for
Rolec - Tara - suspension adaption
146.025.019

main dimensions and
fixing points

dimensions in mm

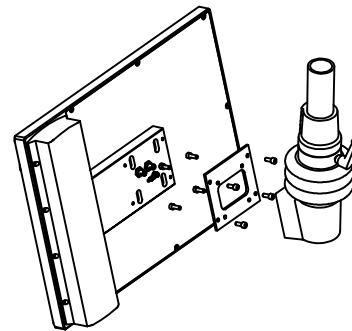

149.025.014

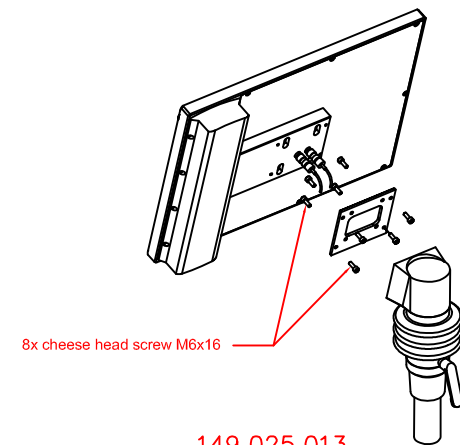

149.025.013