

front view

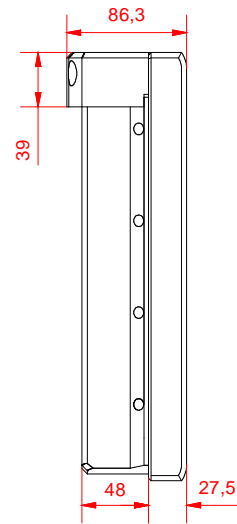

left view

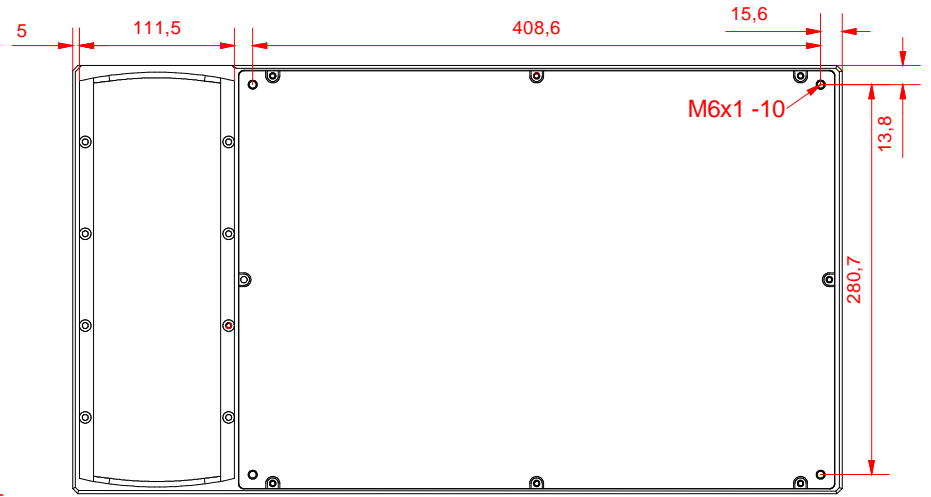

rear view

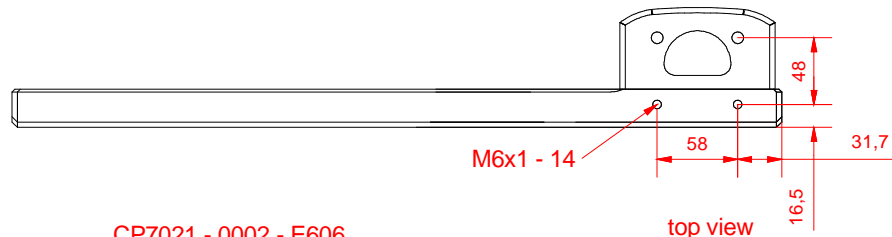

top view

CP7021 - 0002 - E606

arm adapter for
Rolec - Tara - suspension adaption
146.025.019

main dimensions and
fixing points

dimensions in mm

