

front view

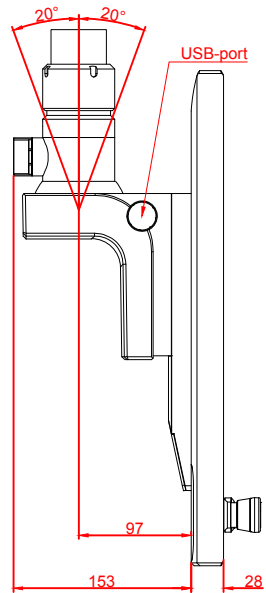

left view

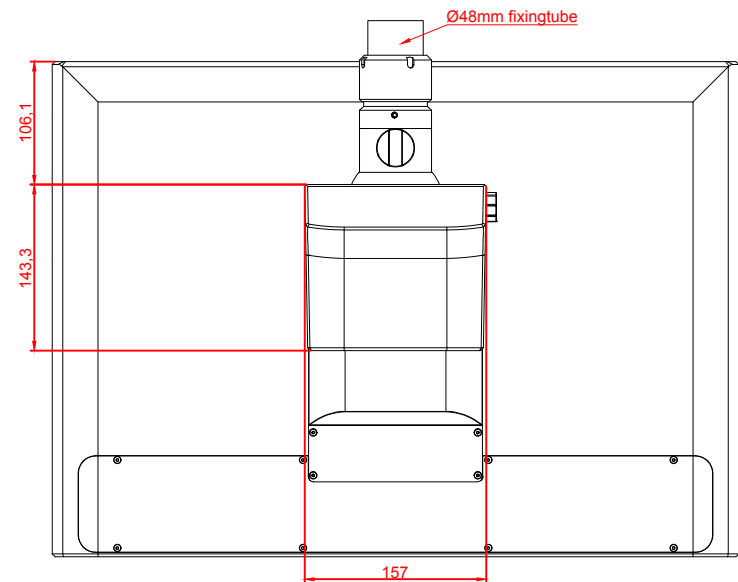

rear view

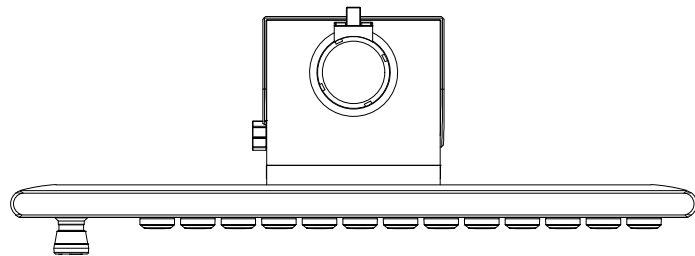

top view

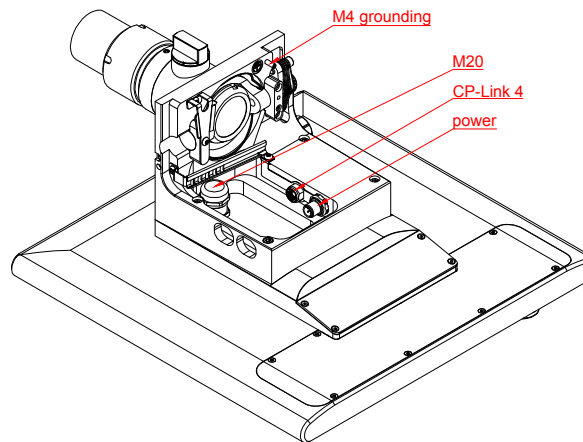

CP3924-G027-0010-M752-E274

main dimensions and
fixing points

dimensions in mm