

front view

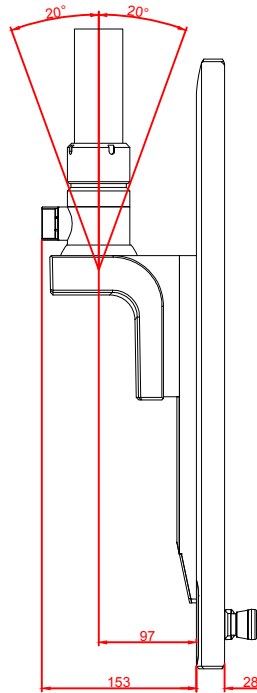

left view

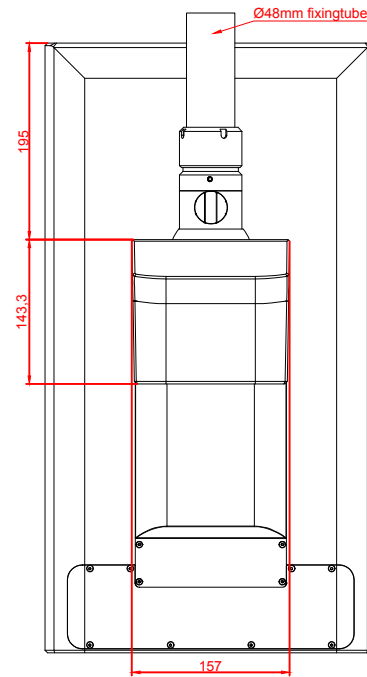

rear view

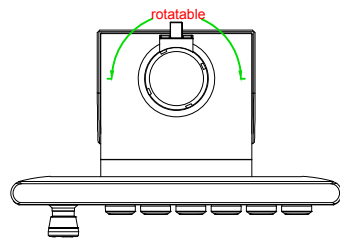

top view

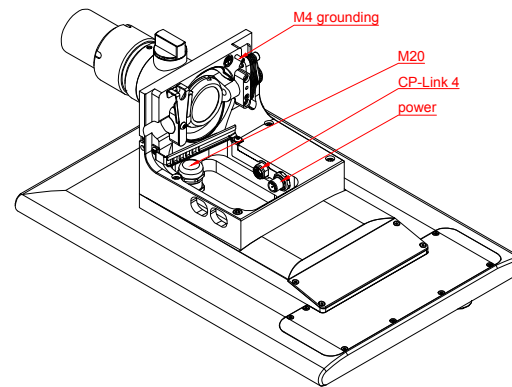

CP3921-G038-0010-M752

main dimensions and
fixing points

dimensions in mm