

CP3921-0010-M575-M751

main dimensions and  
fixing points

dimensions in mm

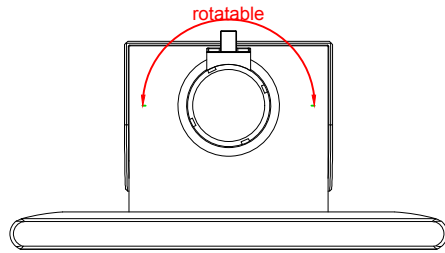

bottom view

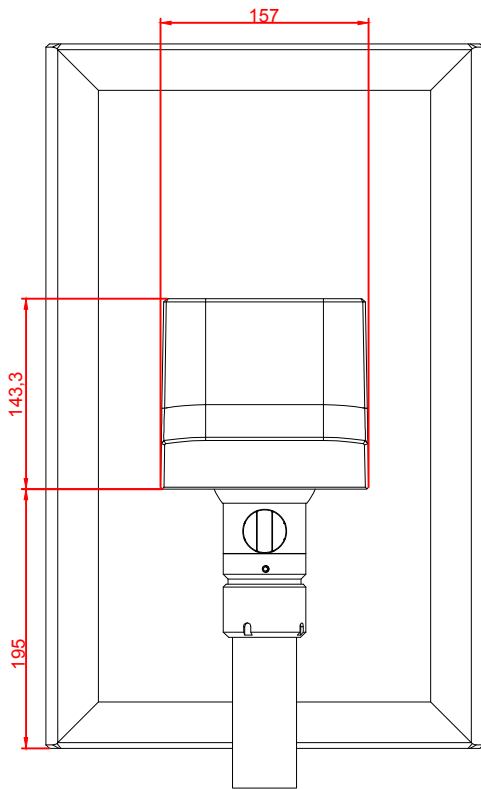
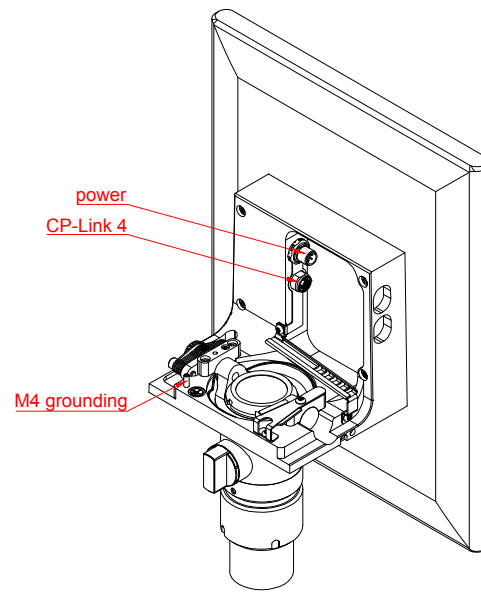

rear view

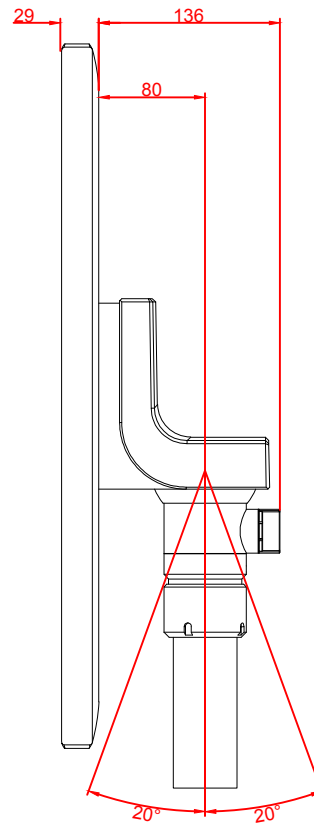

right view

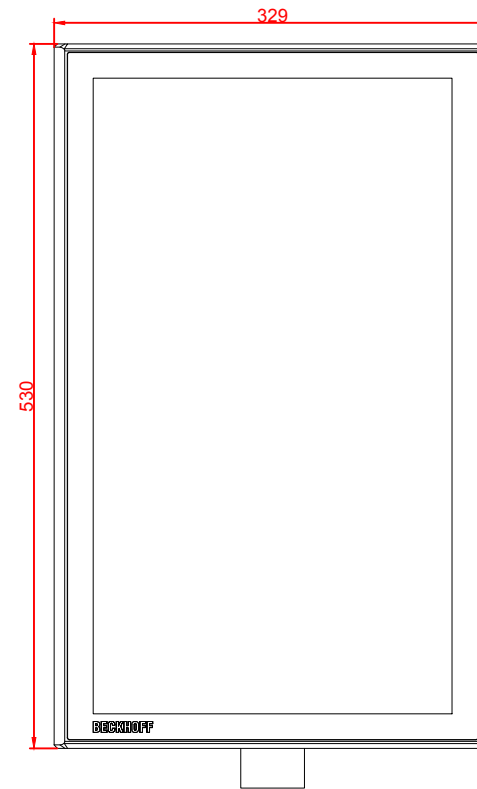

front view