

front view

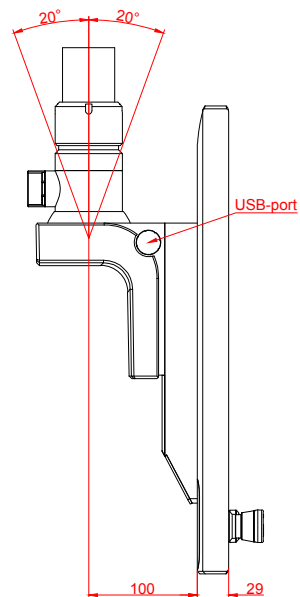

left view

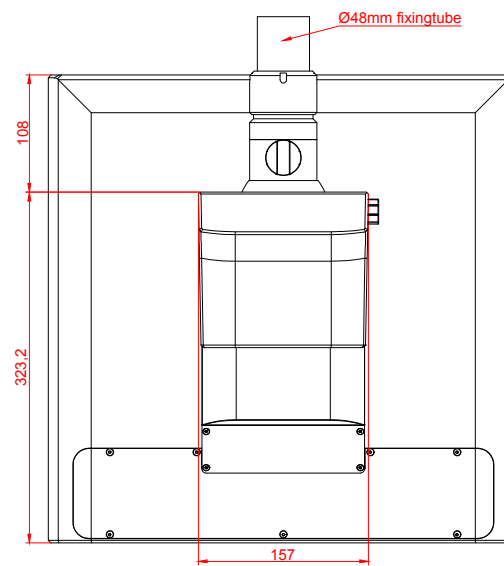

rear view

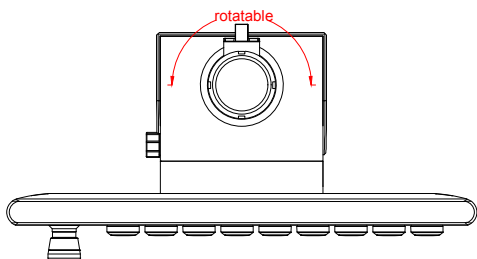

top view

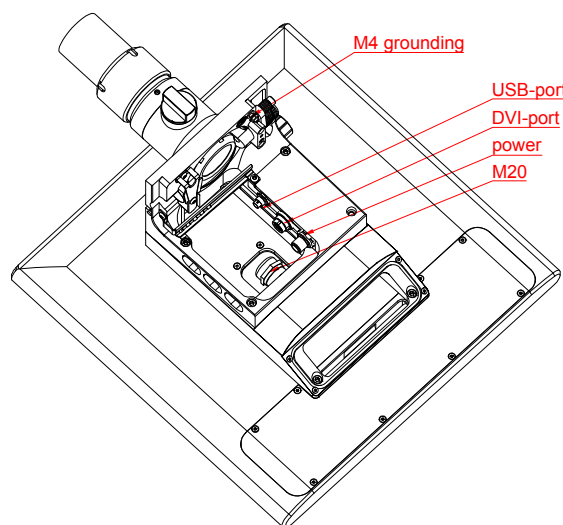

CP3919-G026-M752-E274

main dimensions and  
fixing points

dimensions in mm