

CP3918-0010-M751-M406

main dimensions and
fixing points

dimensions in mm

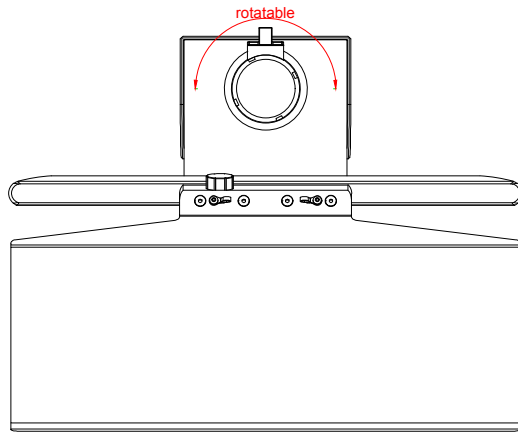

bottom view

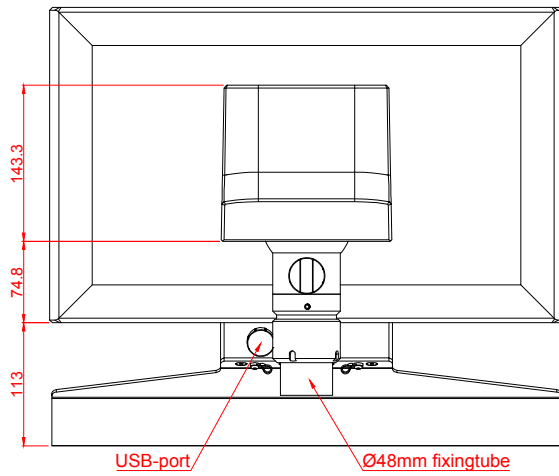
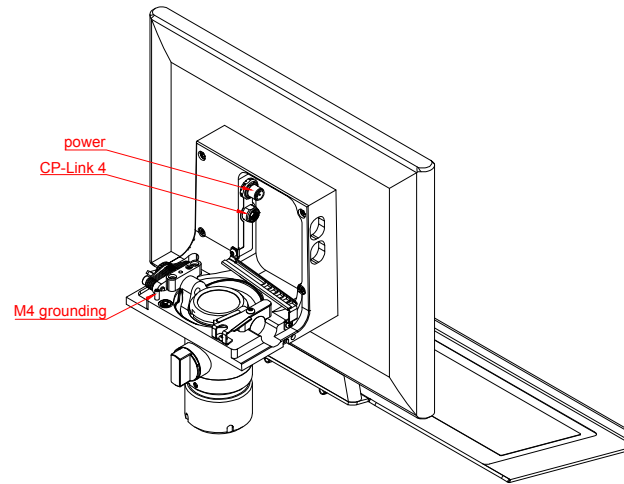

rear view

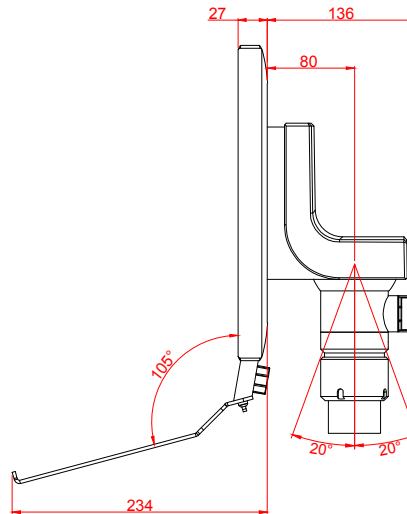

right view

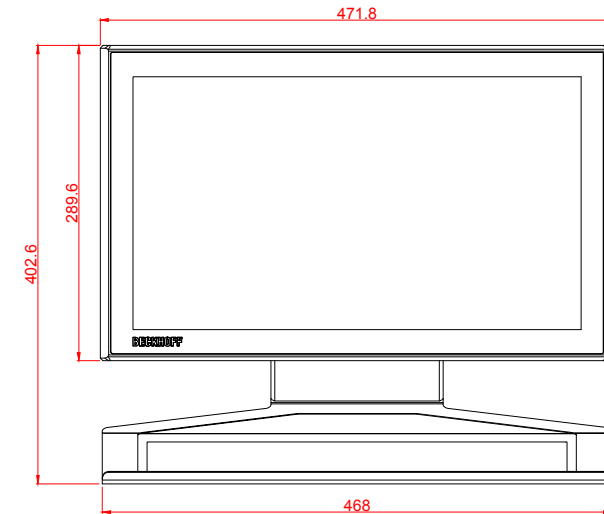

front view