

front view

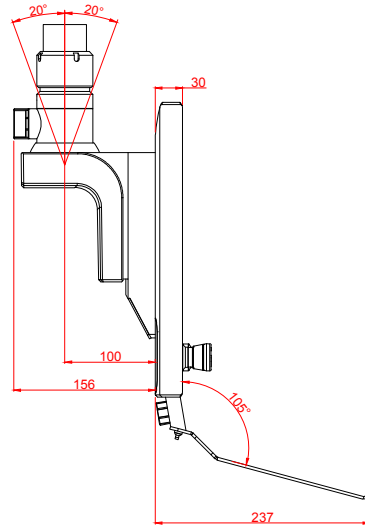

left view

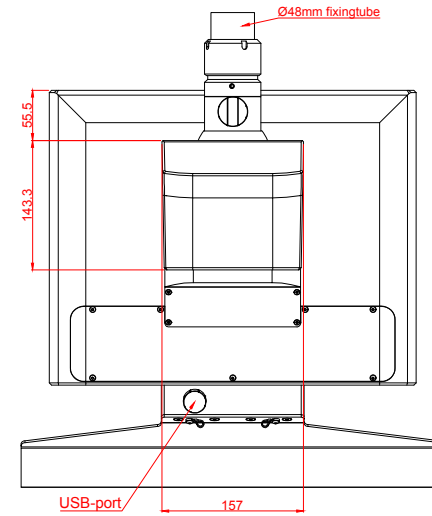

rear view

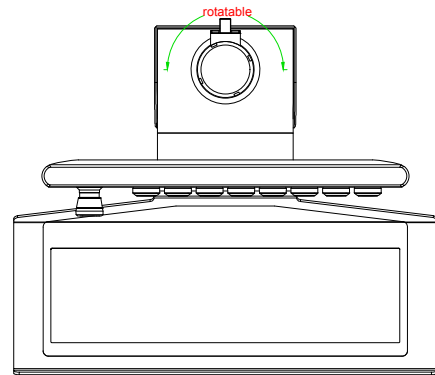

top view

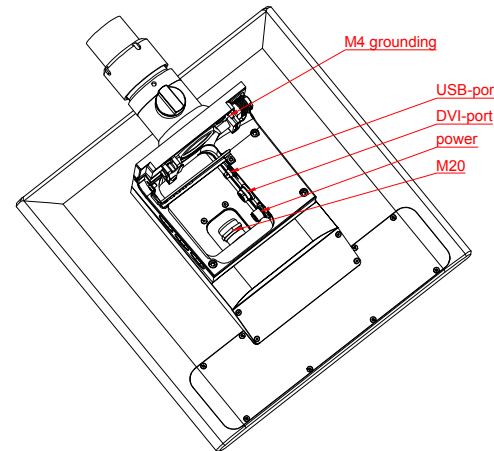

CP3916-G024-M752-M406

main dimensions and
fixing points

dimensions in mm