

front view

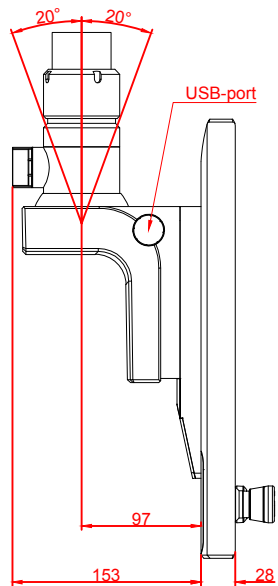

left view

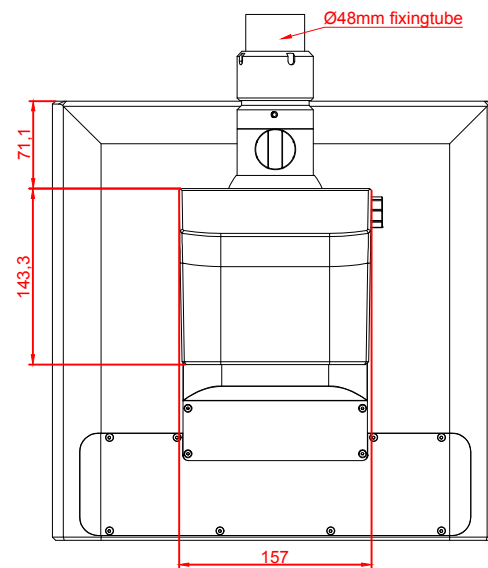

rear view

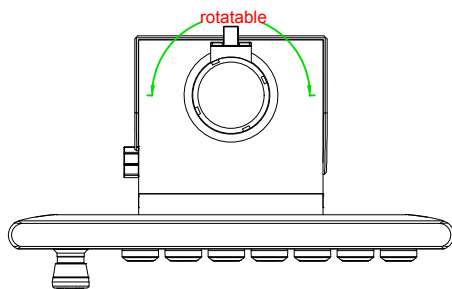

top view

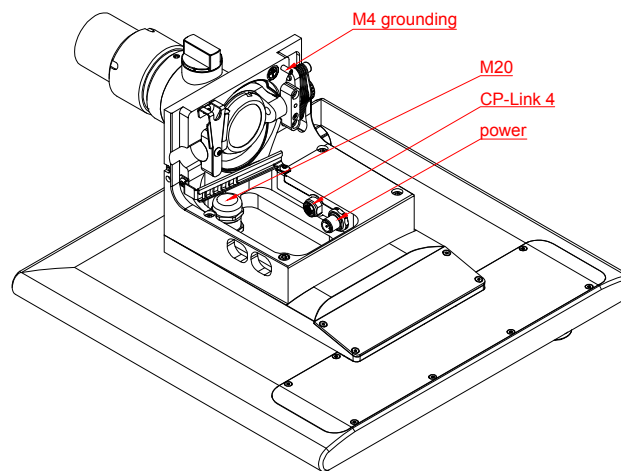

CP3915-G023-0010-M752-E274

main dimensions and
fixing points

dimensions in mm