

front view

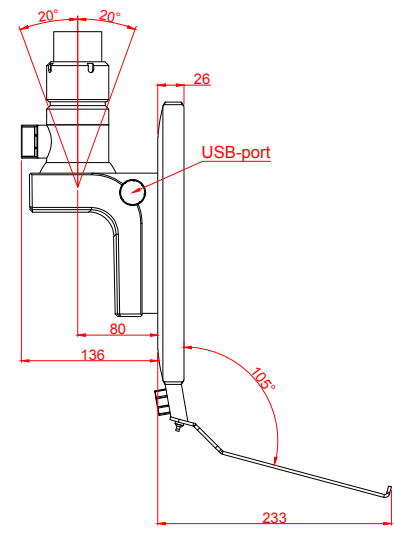

left view

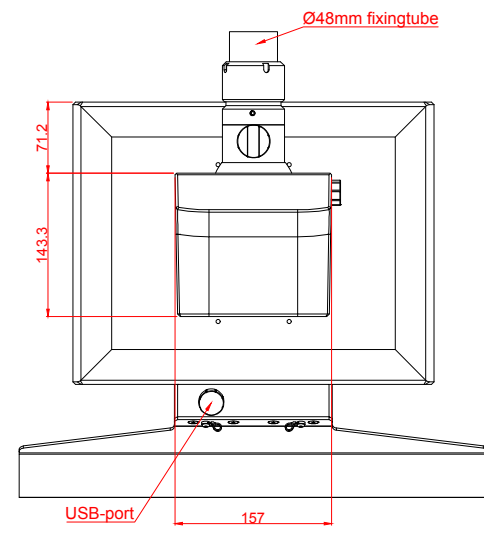

rear view

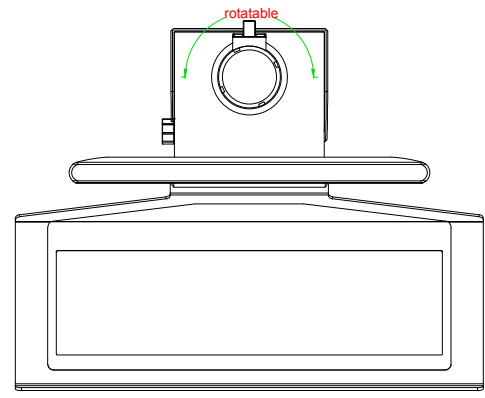

top view

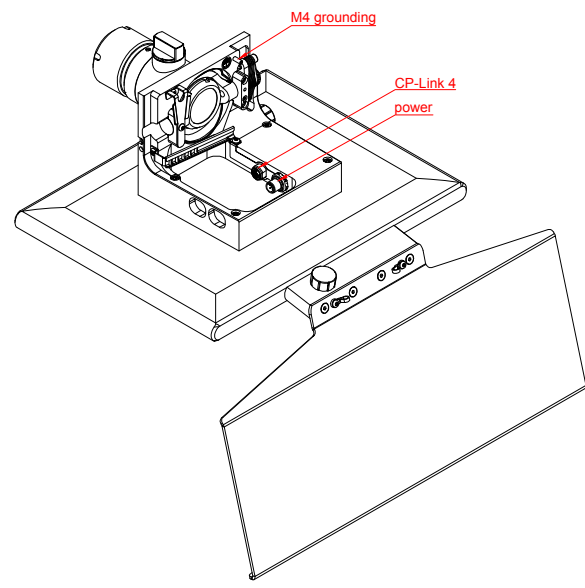

CP3915-0010-M750-E274-M406

main dimensions and fixing points

dimensions in mm