

CP3911-G021-0010-M753

main dimensions and  
fixing points

dimensions in mm

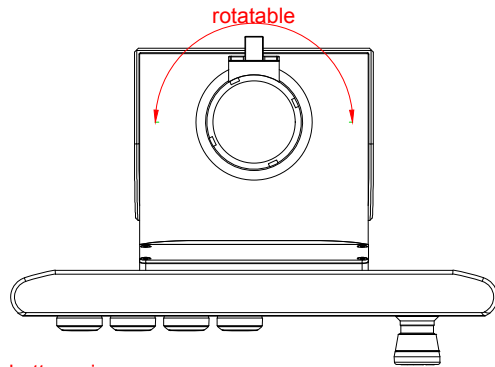

bottom view

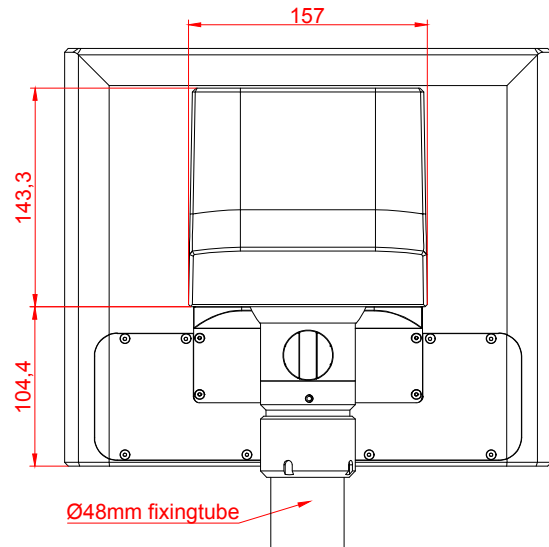
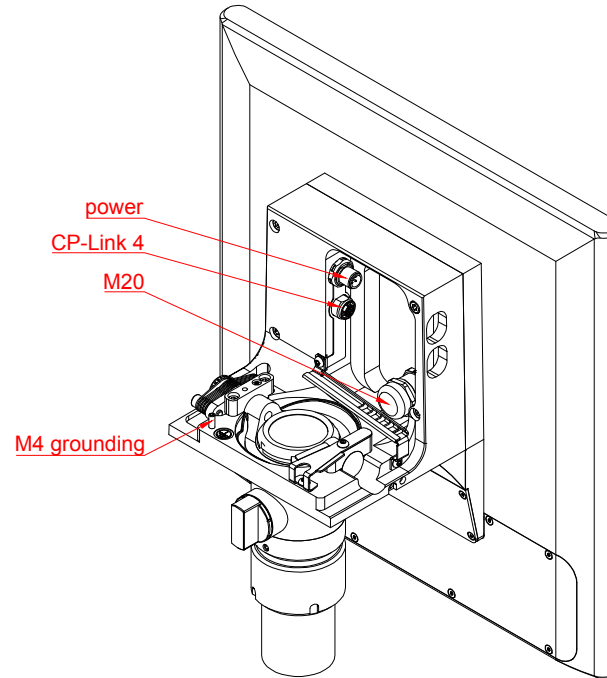

rear view

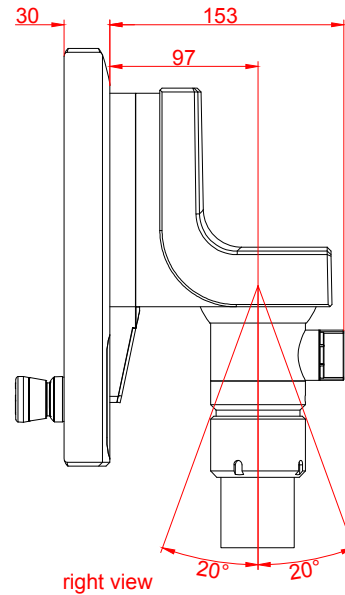

right view

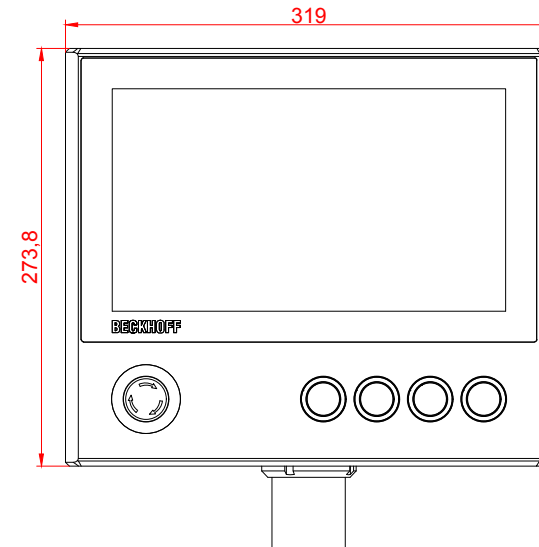

front view