



# Installation and Operating instructions for **Control Cabinet PC C6915**

Version: 1.2  
Date: 2010-09-22

**BECKHOFF**



# Table of contents

<b>1. Foreword</b>	<b>3</b>
Notes on the Documentation	3
Liability Conditions	3
Trademarks	3
Patent Pending	3
Copyright	3
State at Delivery	3
Delivery conditions	3
Description of safety symbols	4
Basic safety measures	5
Operator's obligation to exercise diligence	6
Operator requirements	6
<b>2. Product Description</b>	<b>7</b>
Appropriate Use	7
Access to the battery and drives	7
Status-LEDs	8
Interfaces	9
Power Supply	9
Network connection	9
USB-Interfaces	9
DVI (Digital Visual Interface)	9
Additional plug-in cards (optional)	9
<b>3. Installation Instructions</b>	<b>10</b>
Transport and Unpacking	10
Transport	10
Unpacking	10
Installation of the PC in the control cabinet	11
Earthing measures	11
Power Supply Connection	12
Beckhoff power supply technology	12
Pin assignment of the connector	13
Fitting the cable	14
Material for assembling the connectors	14
Assembling the connectors	14
Connecting Power Supply	15
Cable Cross Sections	15
Configuration for shutting down the PC	15
PC_ON and Power Status functions	15
UPS output	15
UPS output function	15
Wiring diagram	16
Connecting devices	17
Connecting cables	17
Check voltage rating and connect	17
<b>4. Operating Instructions</b>	<b>18</b>
Switching the Industrial PC on and off	18
First switching on and driver installation	18
Maintenance	19
Cleaning the Industrial PC	19
Servicing	19
Replacing the battery on the motherboard	19
Emergency procedures	19
Shutting down	19
Disposal	19

---

<b>5. UPS Software Components (optional)</b>	<b>20</b>
Installation on the PC	20
Help files	20
<b>6. Troubleshooting</b>	<b>21</b>
Fault correction	21
Beckhoff Support & Service	22
Beckhoff branches and partner companies	22
Beckhoff Headquarters	22
Beckhoff Support	22
Beckhoff Service	22
<b>7. Assembly dimensions</b>	<b>23</b>
<b>8. Appendix</b>	<b>25</b>
Technical data	25
Approvals	25
FCC: Federal Communications Commission Radio Frequency Interference Statement	25
FCC: Canadian Notice	25

# Foreword

## Notes on the Documentation

This description is only intended for the use of trained specialists in control and automation engineering who are familiar with the applicable national standards. It is essential that the following notes and explanations are followed when installing and commissioning these components. The responsible staff must ensure that the application or use of the products described satisfy all the requirements for safety, including all the relevant laws, regulations, guidelines and standards.

## Liability Conditions

The documentation has been prepared with care. The products described are, however, constantly under development. For that reason the documentation is not in every case checked for consistency with performance data, standards or other characteristics. In the event that it contains technical or editorial errors, we retain the right to make alterations at any time and without warning. No claims for the modification of products that have already been supplied may be made on the basis of the data, diagrams and descriptions in this documentation.

## Trademarks

Beckhoff<sup>®</sup>, TwinCAT<sup>®</sup>, EtherCAT<sup>®</sup>, Safety over EtherCAT<sup>®</sup>, TwinSAFE<sup>®</sup> and XFC<sup>®</sup> are registered trademarks of and licensed by Beckhoff Automation GmbH.

Other designations used in this publication may be trademarks whose use by third parties for their own purposes could violate the rights of the owners.

## Patent Pending

The EtherCAT Technology is covered, including but not limited to the following patent applications and patents:

EP1590927, EP1789857, DE102004044764, DE102007017835

with corresponding applications or registrations in various other countries.

The TwinCAT Technology is covered, including but not limited to the following patent applications and patents:

EP0851348, US6167425 with corresponding applications or registrations in various other countries.

## Copyright

© Beckhoff Automation GmbH.

The reproduction, distribution and utilization of this document as well as the communication of its contents to others without express authorization are prohibited. Offenders will be held liable for the payment of damages. All rights reserved in the event of the grant of a patent, utility model or design.

## State at Delivery





All the components are supplied in particular hardware and software configurations appropriate for the application. Modifications to hardware or software configurations other than those described in the documentation are not permitted, and nullify the liability of Beckhoff Automation GmbH.

## Delivery conditions

In addition, the general delivery conditions of the company Beckhoff Automation GmbH apply.

## Description of safety symbols

The following safety symbols are used in this operating manual. They are intended to alert the reader to the associated safety instructions.

 <b>DANGER</b>	<b>Acute risk of injury!!</b> If you <b>do not</b> adhere the safety advise adjoining this symbol, there is immediate danger to life and health of individuals!
 <b>WARNING</b>	<b>Risk of injury!</b> If you <b>do not</b> adhere the safety advise adjoining this symbol, there is danger to life and health of individuals!
 <b>CAUTION</b>	<b>Hazard to individuals!</b> If you <b>do not</b> adhere the safety advise adjoining this symbol, there is obvious hazard to individuals!
 <b>Attention</b>	<b>Hazard to devices and environment</b> If you <b>do not</b> adhere the notice adjoining this symbol, there is obvious hazard to materials and environment.
 <b>Note</b>	<b>Note or pointer</b> This symbol indicates information that contributes to better understanding.

## Basic safety measures

Only switch the PC off after closing the software

**Before the Industrial PC is switched off, software that is running must be properly closed.**

Otherwise it is possible that data on the hard disk is lost. Please read the section on [Switching the Industrial PC on and off](#).

 <b>Attention</b>	<p><b>Switch off all parts of the equipment, then uncouple the fieldbus</b></p> <p>Before opening the housing of the PC, and whenever the PC is being used for purposes other than plant control, such as during functional tests following repair, all parts of the equipment must first be switched off, after which the Industrial PC can be uncoupled from the plant.</p> <p>Pulling out the fieldbus connection plug uncouples the PC (optional).</p> <p>Items of equipment that have been switched off must be secured against being switched on again.</p>
---	---

The Industrial PC's power supply unit must be supplied with 24 V<sub>DC</sub>.

 <b>Attention</b>	<p><b>Do not exchange any parts when under power</b></p> <p>When components are being fitted or removed, the supply voltage must be switched off.</p> <p>Fitting work on the Industrial PC can result in damage:</p> <ul style="list-style-type: none"> <li>• if metal objects such as screws or tools fall onto operating circuit boards.</li> <li>• if connecting cables internal to the PC are removed or inserted during operation.</li> <li>• if plug-in cards are removed or inserted when the PC is switched on.</li> </ul>
---	--

## Operator's obligation to exercise diligence

The operator must ensure that

- the Industrial PC is only used for its intended use (see also [Product Description](#) chapter).
- the Industrial PC is in a sound condition and in working order during operation (see also chapter [Maintenance](#)).
- the operation manual is in good condition and complete, and always available for reference at the location of the Industrial PC.
- the Industrial PC is operated, maintained and repaired only by sufficiently qualified and authorized personnel.
- the personnel is instructed regularly about relevant occupational safety and environmental protection aspects, and is familiar with the operating manual and in particular the safety notes contained herein.
- none of the safety and warning notes attached to the Industrial PC are removed, and that all notes remain legible.

*National regulations depending on the machine type*

Depending on the type of machine and plant in which the Industrial PC is being used, there will be national regulations for the control of such machines and plant that the operator must observe. These regulations cover, amongst other things, the intervals between inspections of the controller.

The operator must initiate such inspections in good time.



**Attention**

### **Only trained persons may open the Industrial PC housing!**

The operator is responsible for ensuring that only trained electrical staff opens the housing of the Industrial PC.

*Procedure in the event of a fault*

In the event of a fault in the Industrial PC, appropriate measures can be determined with the aid of the list in the [Fault correction](#) section.

## Operator requirements

*Read the operating instructions*

Every user of the Industrial PC must have read these operating instructions.

*Software knowledge*

Every user must be familiar with any of the functions of the software installed on the PC that he can reach.

# Product Description

## Appropriate Use

The C6915 Industrial PC is designed for mounting in control cabinets for machine and plant engineering applications.

Front view of Industrial PC  
C6915

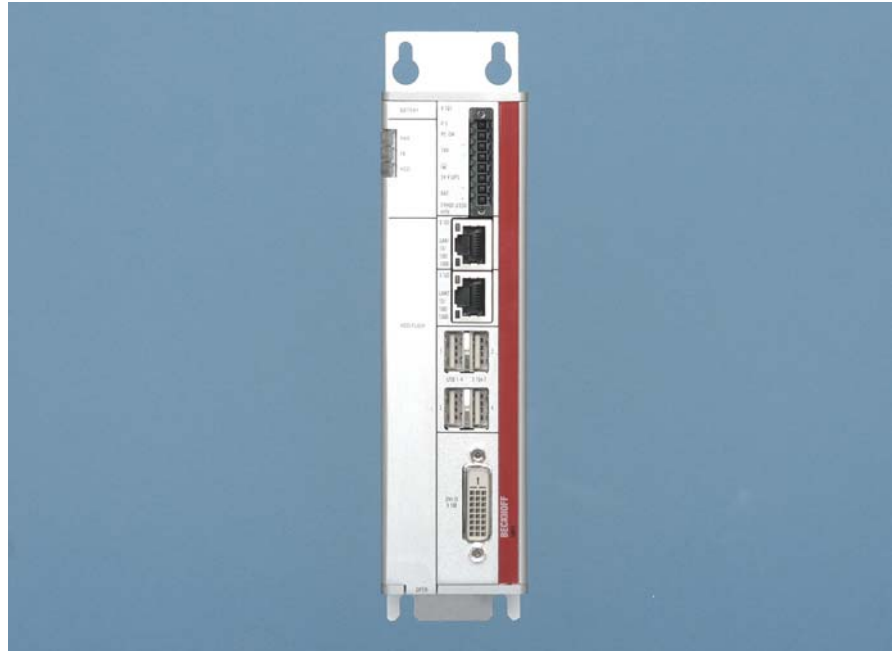

### Configuration

The compact housing is equipped with a 3½-inch motherboard with Intel® Atom™. All PC connections are located at the front of the housing.

Cooling through the aluminium surface enables operation of the Industrial PC at temperatures up to 55 °C, with installed hard disk up to 45 °C.

## Access to the battery and drives

Access to the battery, the  
CF-Card and the hard disk  
(optional)

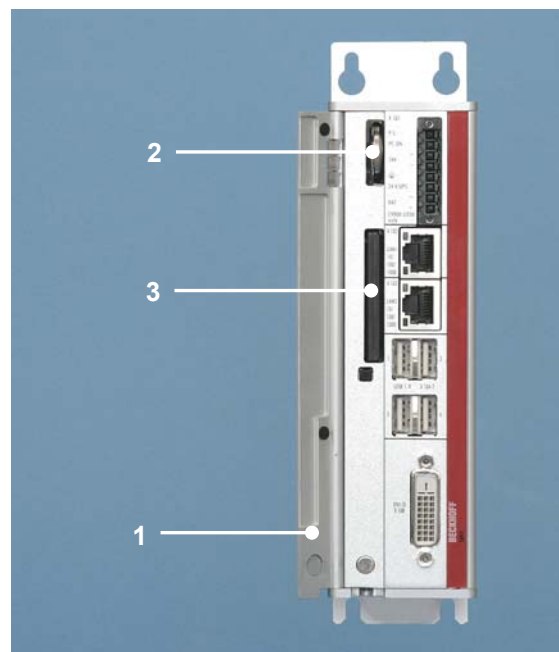

Opening the front flap (1) allows access to the battery (2) and the CF-Card (3). Optionally the Industrial PC can be fitted with a second CF-Card or only with one hard disk.

## Status-LEDs

### Description of the Status-LEDs

The Status-LEDs (**2**) are located near the power supply connector (**X101**):



1	PWR (Power):	green off	Industrial PC is busy Industrial PC is off
2	FB (Fieldbus):	red blue blue/ red blinking green green/ red blinking	TwinCAT Stop Mode TwinCAT Configuration Mode TwinCAT Config (Fieldbus Error) TwinCAT Run Mode TwinCAT Run (Fieldbus Error)
3	HDD (Hard disk):	red	Access to a memory device

## Interfaces

*Interfaces to the C6915 Industrial PC*

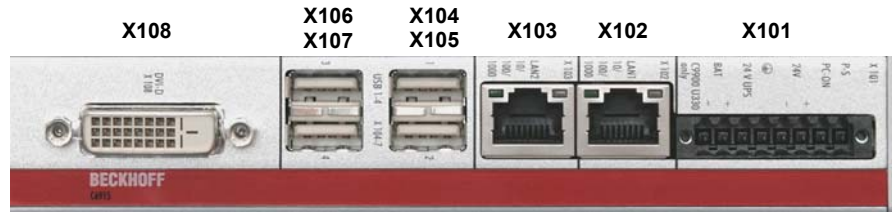

*Power supply*

### Power Supply

The power supply for the Industrial PC is established via the socket (**X101**).

*Network 10/100/1000 BASE-T*

### Network connection

The RJ-45 connector (**X102**) allows the PC to be connected to a 10/100/1000 BASE-T Local Area Network (LAN).

*Network 10/100/1000 BASE-T*

The RJ-45 connector (**X103**) allows the PC to be connected to a 10/100/1000 BASE-T Local Area Network (LAN).

*USB1 – USB4*

### USB-Interfaces

The four USB interfaces (**X104 – X107**) are used for connecting peripheral devices with USB connection. USB2.0 standard is supported.

*DVI-D*

### DVI (Digital Visual Interface)

The DVI connection (**X108**) is used for transferring the video signal. DVI-D standard is supported.

*Type plate*

### Additional plug-in cards (optional)

There is a type plate on the top of the Industrial PC which provides information about the hardware configuration of the Industrial PC at the time it was supplied.

*Ground connection*



# Installation Instructions

Please also refer to chapter [Foreword](#).

## Transport and Unpacking

The specified storage conditions must be observed (see chapter [Technical data](#)).

### Transport

Despite the robust design of the unit, the components are sensitive to strong vibrations and impacts. During transport, your Industrial PC should therefore be protected from excessive mechanical stress. Therefore, please use the original packaging.



#### Attention

#### Danger of damage to the unit

If the device is transported in cold weather or is exposed to extreme variations in temperature, make sure that moisture (condensation) does not form on or inside the device.

Prior to operation, the unit must be allowed to slowly adjust to room temperature. Should condensation occur, a delay time of approximately 12 hours must be allowed before the unit is switched on.

### Unpacking

Proceed as follows to unpack the unit:

1. Remove packaging.
2. Do not discard the original packaging. Keep it for future relocation.
3. Check the delivery for completeness by comparing it with your order.
4. Please keep the associated paperwork. It contains important information for handling the unit.
5. Check the contents for visible shipping damage.
6. If you notice any shipping damage or inconsistencies between the contents and your order, you should notify Beckhoff Service.



## Installation of the PC in the control cabinet

The C6915 Industrial PC is designed for mounting in control cabinets for machine and plant engineering applications.

The ambient conditions specified for operation must be observed (see chapter *Technical data*).

*Preparation of the control cabinet*

Four holes for the fixing bolts have to be provided in the control cabinet according to the dimensions of the PC (see chapter *Assembly dimensions*).

 <p><b>Note</b></p>	<p><b>Circulation of air</b></p> <p>When the unit is installed in an enclosure, adequate space for ventilation and for opening the PC must be provided.</p> <p>The clearance above and below the housing must be at least 5 cm in order to ensure adequate ventilation of the PC.</p>
 <p><b>Attention</b></p>	<p><b>Avoid extreme environmental conditions</b></p> <p>Extreme environmental conditions should be avoided as far as possible. Protect the PC from dust, moisture and heat.</p> <p>The ventilation slots of the PC must not be covered.</p>

*Earthing measures*





### Earthing measures

Earthing connections dissipate interference from external power supply cables, signal cables or cables to peripheral equipment.

Establish a low-impedance connection from the earthing point on the PC housing to the central earthing point on the control cabinet wall, in which the computer is being installed. The earthing connection is located at the mounting plate of the Industrial PC (see photograph on the left).

## Power Supply Connection

*Supplied mains power unit* The Industrial PC is fitted with a 24 V<sub>DC</sub> power supply unit .

 <b>Note</b>	<p><b>Uninterruptible power supply (UPS)</b></p> <p>When the Industrial PC is provided with a power supply unit with integrated UPS (order option) you can realize an uninterruptible power supply (UPS) using the battery pack C9900-U330.</p>
 <b>WARNING</b>	<p><b>Danger of Explosion!</b></p> <p>Danger of Explosion if using other battery packs!</p>

### Beckhoff power supply technology

*Schematic diagram of power supply unit wirings*

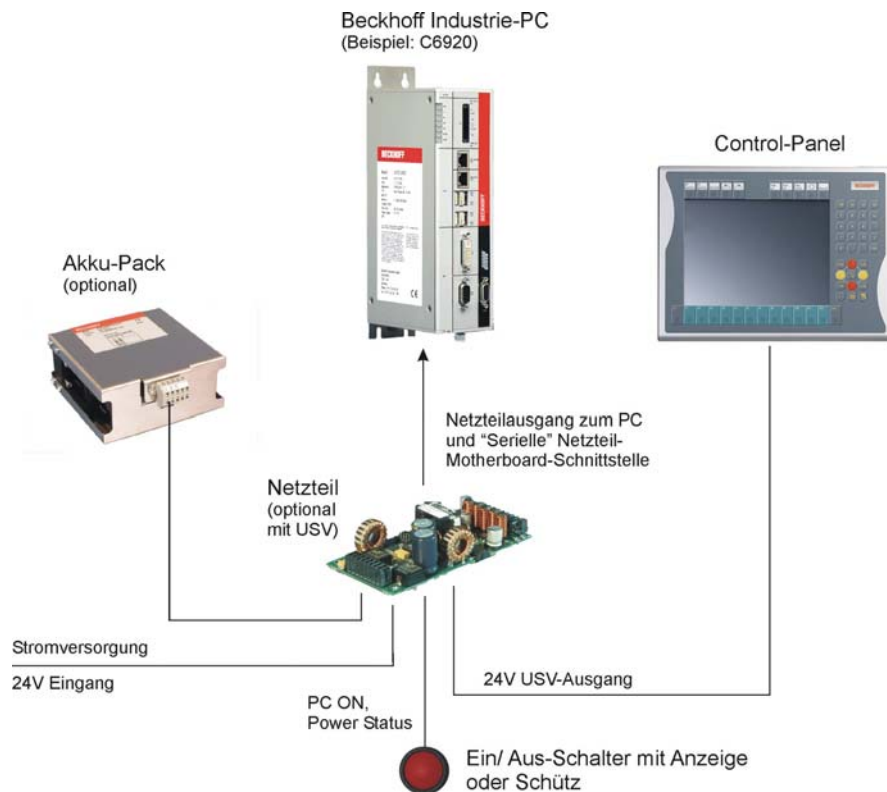

*Innovative solution for shutting down Industrial PCs*

Industrial PCs equipped with a UPS are in actual use frequently switched off by simply turning off the supply voltage. In this case the PC shuts down via the battery. However, over time this reduces the service life of the battery.

The new Beckhoff power supply technology approach addresses this problem and now offers the user the option of switching the PC off without the need for using the battery, thereby reducing the load on the battery.

In addition to the main switch this innovative solution uses an ON/OFF switch for the machine. Basically, the main switch remains switched on and provides the power supply for the PC during shutdown. Via the PC ON-input of the power supply the PC gets the command to shut down the operating system.

Once the PC has shut down, the PC power supply unit sets the Power Status-output (P-S) to 0, what indicates that the process is complete and

that the main voltage can be switched off. This can be done manually via a signal lamp connection or via a contactor. With this solution the main switch generally only has to be switched off if the control cabinet has to be opened. The battery will only be used in the event of a power failure.

In order to maintain a screen display for the Industrial PC in the event of a power failure, the power supply unit is equipped with a UPS output 27 V / 1.4 A for connecting a Control Panel with a display dimension up to 19 inches. This enables a power failure to be visualized and displayed to the user. Once the PC has shut down, the UPS output is switched off.

For a detailed functional description please refer to section [Connecting Power Supply](#).

### Pin assignment of the connector

The power supply and the external circuit for switching the Industrial PC on and off are connected via the 8-pole plug connector .

*Pin assignment for connecting the switch, the power supply and the battery pack (optional)*



Pin	Function	
1	-	Battery Pack
2	+	(with UPS only)
3	UPS+ (Output)	
4	⊕	
5	-	24 V DC
6	+	Power Supply
7	PC_ON	
8	Power-Status	

## Fitting the cable

*Wiring in accordance with wiring diagram*

Fit the cables for the power supply of the Industrial PC, the connection of the battery pack as well as the connection of the power-switch in accordance with the wiring diagram, using the included material for assembling the connectors.

### Material for assembling the connectors

*Material for assembling the connectors*

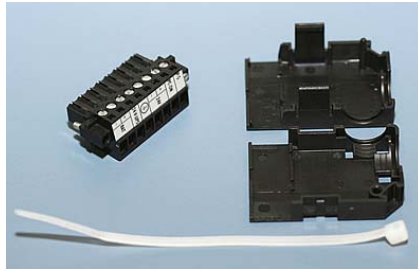

Plug connector 8-pole, Strain relief housing with lacing cord

### Assembling the connectors

*Conductive cross-section*

The connector is specified for 16 A and can lift conductive cross-sections until 1.5 mm<sup>2</sup>.

*Fitting the connector to the cable*

So the connector is fitted to the cable:

1. Strip insulation from the cable ends (Length of stripped conductor is 8 – 9 mm).
2. Screw together the cable ends in the 8-pole plug connector in accordance with wiring diagram.

*Applying the strain relief*



Thread the lacing cord into that lower part of the strain relief housing.

*Putting in the plug connector*

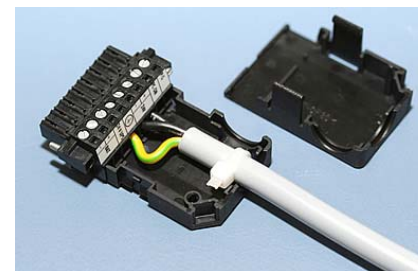

Put the plug connector into that lower part of the strain relief housing. Tighten the lacing cord and pinch off the plastic strap.

*Fixing the upper part of the strain relief housing*



Fix the upper part of the strain relief housing by snapping it onto the lower part.

## Connecting Power Supply

The external wiring consists of the connection of the power supply, the battery pack (optional) and the connection of customized components for shutting down the PC.

### Cable Cross Sections

*Note cable cross sections, avoid voltage drop!*

For the connection of the power supply, wiring with a cable-cross-section of 1.5 mm<sup>2</sup> must be used.

With bigger distances between voltage source and PC, you take the voltage drop as a function of the cable-cross-section as well as voltage fluctuations of your distribution voltage into account, so that is secured that the voltage doesn't fall under 22 V at the power supply.

 <b>Attention</b>	<b>Insert fuse</b> The power supply must be protected with maximum 16 A.
---	---

### Configuration for shutting down the PC

The connections for shutting down the Industrial PCs are established via the **PC\_ON** input and the **Power Status** output.

#### PC\_ON and Power Status functions

- If the **PC\_ON** input is connected to 24 V via a switch, the PC shuts down according to the rules. The **PC\_ON** signal is inverted, i.e. the PC shuts down if the 24 V connection is live.
- If the **PC\_ON** input is *NOT* connected by the user, the PC can be booted in the familiar way by connecting the supply voltage and shut down via the battery by switching off the supply voltage.

 <b>Attention</b>	<b>Service life of the rechargeable battery</b> This procedure significantly reduces the service life of the rechargeable battery and should therefore not be used.
---	--

- Once the PC has shut down, the **Power Status** output is switched from 24 V to 0 V. Via this output a signal lamp can be connected or a contactor for de-energizing the whole system. The maximum load for the **Power Status** output is 0.5 A and a suitable fuse should be provided.

### UPS output

In order to maintain a screen display for the PC in the event of a power failure, the power supply unit is equipped with a **UPS output** for connecting a Control Panel. The maximum load for the output is 1.4 A.

#### UPS output function

- The 24 V DC connection at the UPS output is live even after a power failure. The maximum load is 1.4 A.
- Once the PC has been de-energized via the UPS software, the **UPS output** is switched to 0 V. Any connected panel is thus switched off, and total discharge of the rechargeable battery is prevented.

### Wiring diagram

Wiring according to the wiring diagram (the circuit of PC\_ON and Power-Status is symbolical):

*Wiring diagram external switch and power supply*

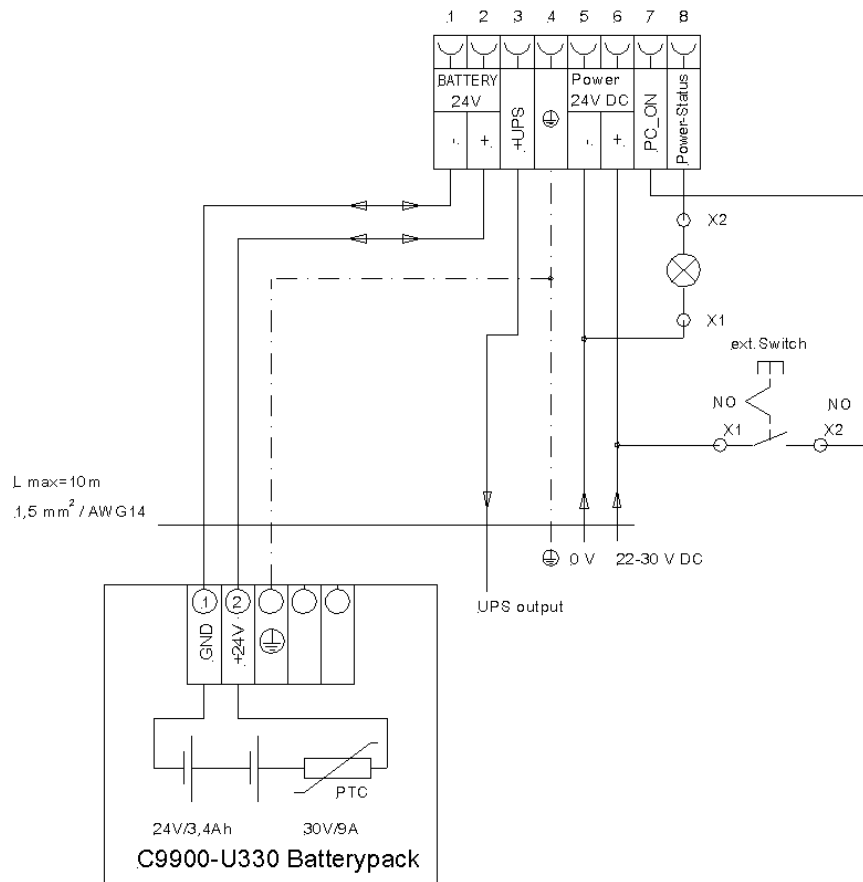

**Note**

#### Connection of the Battery Pack and UPS Output

Connection of the Battery Pack and UPS Output only in combination with integrated UPS (order option).

## Connecting devices

 <p><b>Attention</b></p>	<p><b>Power supply plug</b></p> <p>The power supply plug must be withdrawn!</p> <p>Please read the documentation for the external devices prior to connecting them.</p> <p>During thunderstorms, plug connector must neither be inserted nor removed.</p> <p>When disconnecting a plug connector, always handle it at the plug. Do not pull the cable!</p>
---	--

### Connecting cables

The connections are located at the top of the Industrial PC and are documented in the product description chapter.

When connecting the cables to the Industrial PC, proceed according to the following sequence:

- Switch off all the devices that are to be connected.
- Disconnect all the devices that are to be connected from the power supply.
- Connect all the cables between the Industrial PC and to the devices that are to be connected.
- Connect all data transfer cables (if present) to the appropriate plug-in receptacles of the data/telecommunication networks.
- Reconnect all devices to the power supply.

### Check voltage rating and connect

#### Fitted with the 24 V<sub>DC</sub> power supply unit:

1. Check that the external power supply is providing the correct voltage.
2. Insert the power supply cable that you have assembled into the Industrial PC's power supply socket. Then connect it to your external 24 V power supply.

 <p><b>Attention</b></p>	<p><b>Use same type of rechargeable battery</b></p> <p>If a 24 V UPS is installed, the same type of rechargeable battery must be used.</p>
---	--

# Operating Instructions

Please also refer to chapter [Foreword](#).

## Switching the Industrial PC on and off

### Switch on

The Industrial PC does not have its own mains switch. The Industrial PC will start when the equipment is switched on, or when it is connected to the power supply.

### Shutting down and switching off

When the plant is switched off, or when it is disconnected from its power supply, the Industrial PC will be switched off.

Control software such as is typically used on Industrial PCs permits various users to be given different rights. A user who may not close software may also not switch the Industrial PC off, since data can be lost from the hard disk by switching off while software is running.



#### Attention

#### First shut down, then switch off the PC

If the Industrial PC is switched off as the software is writing a file to the hard disk, the file will be destroyed. Control software typically writes something to the hard disk every few seconds, so that the probability of causing damage by switching off while the software is running is very high.



#### Attention

#### Switch off power supply

When you have shut down the Industrial PC, you have to switch off power supply for at least 10 seconds before rebooting the system. After resetting power supply the PC will start booting automatically.

## First switching on and driver installation

When you switch on the Industrial PC for the first time, the pre-installed operating system (optional) will be started. In this case, all the required drivers for any additional, optional hardware components ordered with the PC will already have been installed.

If the PC was ordered without operating system, you have to install the operating system and the driver software for any auxiliary hardware yourself. Please follow the instructions in the documentation for the operating system and the additional devices.

## Maintenance

Please also refer to chapter [Foreword](#).

### Cleaning the Industrial PC

 <b>Attention</b>	<p><b>Disconnect from power supply</b></p> <p>Switch off the Industrial PC and all connected devices, and disconnect the Industrial PC from the power supply.</p>
---	---

The Industrial PC can be cleaned with a soft, damp cloth. Do not use any aggressive cleaning materials, thinners, scouring material or hard objects that could cause scratches.

### Servicing

The Industrial PC requires no maintenance.

### Replacing the battery on the motherboard

A used battery on the motherboard has to be replaced. See also chapter [Access to the battery and drives](#).

 <b>WARNING</b>	<p><b>Danger of Explosion!</b></p> <p>Replace battery only with the identical type or an alternative type recommended by the manufacturer. Notice correct polarity!</p>
--	---

The used battery must be disposed of in accordance with national electronics scrap regulations.

## Emergency procedures

In case of fire, the Industrial PC should be extinguished with powder or nitrogen.

## Shutting down

### Disposal

*Dismantling the Industrial PC*

The device must be fully dismantled in order to dispose of it. The housing can be sent for metal recycling.

*Observe national electronics scrap regulations*

Electronic parts such as disk drives and circuit boards must be disposed of in accordance with national electronics scrap regulations.

## UPS Software Components (optional)

### *Installing the UPS driver software*

For operating the power supply unit as a UPS, the UPS driver software and the associated UPS driver must be installed on the Industrial PC.

On delivery of the Beckhoff Industrial PC with operating system the software is already installed. Should the software not be installed on your PC, the drivers can be installed from the driver CD provided.

### **Installation on the PC**

#### *Installation*

To install the UPS driver software, execute file

**Beckhoff\_UPS\_vx.xx.xx.exe** from the subdirectory of **UPS\...** from the CD provided on the Industrial PC (Driver-archive for the Industrial-PC, C9900-S700-xxxx).

The program is self-extracting and will guide the user through the installation routine.

### **Help files**

#### *Beckhoff Information System*

The driver software comes with a detailed help function.

The help files can be called up either directly from the configuration register by clicking the Help button, or under via *Start > Programs > Beckhoff > UPS software components*.

# Troubleshooting

Please also refer to chapter [Foreword](#).

## Fault correction

Fault	Cause	Procedure
Nothing happens after the Industrial PC has been switched on	No power supply to the Industrial PC.	Check power supply cable.
	Other cause.	Call Beckhoff Service.
The Industrial PC does not boot fully	Setup settings are incorrect.	Check the setup settings.
	Other cause.	Call Beckhoff Service.
Computer boots, software starts, but control does not operate correctly	Cause of the fault is either in the software or in parts of the plant outside the Industrial PC.	Call the manufacturer of the machine or the software.
Memory device access error	Faulty device.	Call Beckhoff Service.
The Industrial PC functions only partially or only part of the time, e.g. no or dark picture, but disk drive responds when switching on	Defective components in the Industrial PC.	Call Beckhoff Service.

## Beckhoff Support & Service

Beckhoff and their partners around the world offer comprehensive support and service, guaranteeing fast and competent assistance with all questions related to Beckhoff products and system solutions.

### Beckhoff branches and partner companies

Please contact your Beckhoff branch office or partner company for [local support and service](#) on Beckhoff products!

The contact addresses for your country can be found in the list of Beckhoff branches and partner companies: [www.beckhoff.com](http://www.beckhoff.com)

You will also find further [documentation](#) for Beckhoff components there.

### Beckhoff Headquarters

Beckhoff Automation GmbH  
Eiserstraße 5  
33415 Verl  
Germany

Phone: +49(0)5246/963-0  
Fax: +49(0)5246/963-198  
e-mail: [info@beckhoff.com](mailto:info@beckhoff.com)

### Beckhoff Support

Beckhoff offers you comprehensive technical assistance, helping you not only with the application of individual Beckhoff products, but also with wide-ranging services:

- worldwide support
- design, programming and commissioning of complex automation systems
- training program for Beckhoff system components

Hotline: +49(0)5246/963-157  
Fax: +49(0)5246/963-9157  
e-mail: [support@beckhoff.com](mailto:support@beckhoff.com)

### Beckhoff Service

The Beckhoff service center supports you in all matters of after-sales service:

- on-site service
- repair service
- spare parts service
- hotline service

Hotline: +49(0)5246/963-460  
Fax: +49(0)5246/963-479  
e-mail: [service@beckhoff.com](mailto:service@beckhoff.com)

*Quote the project number* If servicing is required, please quote the **project number** of your product.

# Assembly dimensions

The following pages show diagrams of the Industrial PC, with dimensions in mm.

## Industrial PC C6915

Mounting back

 <b>Attention</b>	<b>Assembly orientation</b> The assembly of the unit must take place with the orientation diagrammed here.
---	---

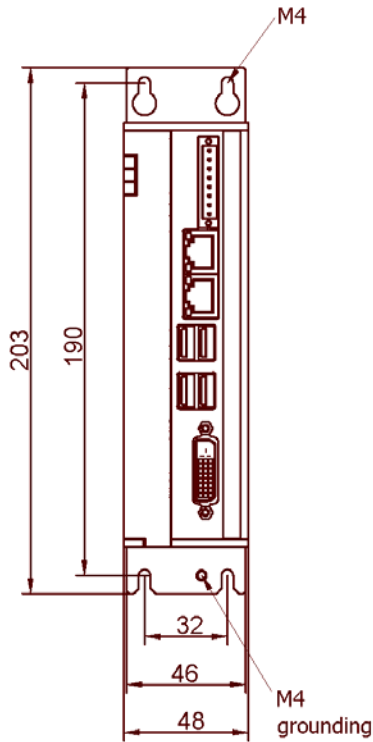

front view

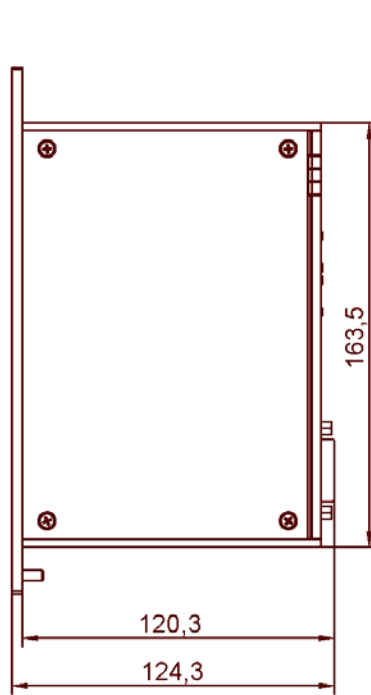

left view

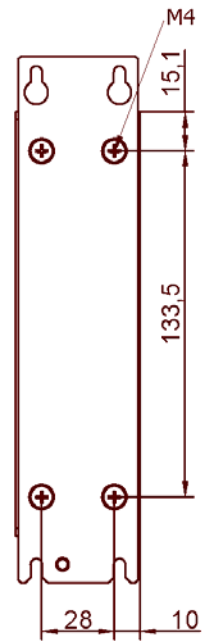

back view

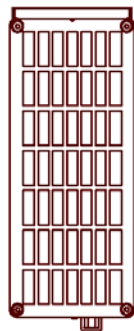

top view

**C6915-C9900-M**

Mounting side



**Attention**

**Assembly orientation**

The assembly of the unit must take place with the orientation diagrammed here.

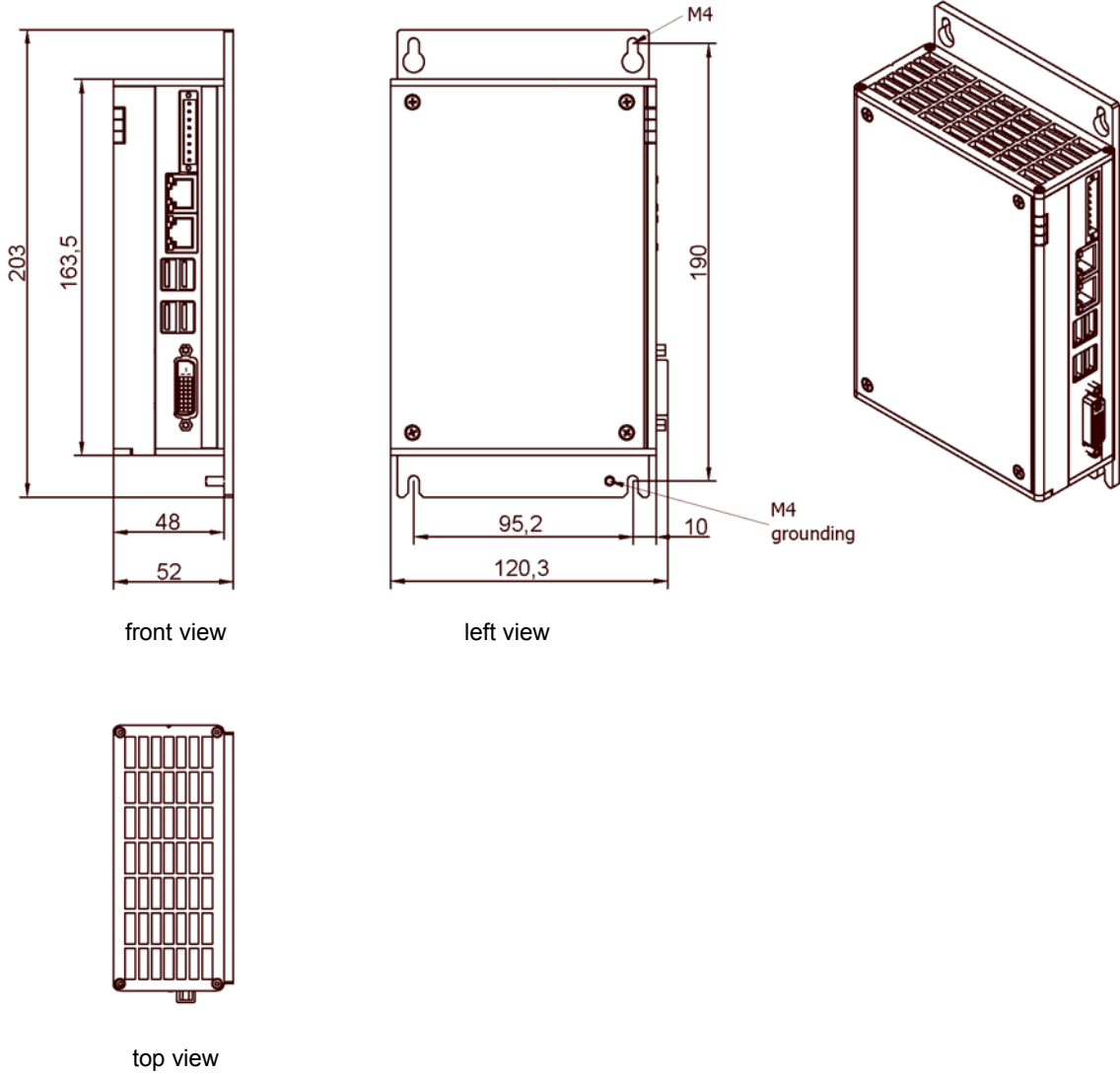

# Appendix

## Technical data

<i>Industrial-PC C6915</i>	<b>Dimensions (W x H x D):</b>	47 x 157 x 116 mm (without mounting plate)
	<b>Weight:</b>	1.25 kg (basic configuration)
<i>Do not use the PC in areas of explosive hazard</i>	<b>The Industrial PC may not be used in areas of explosive hazard.</b>	
	<b>The following conditions must be observed during operation:</b>	
<i>Environmental conditions</i>	<b>Ambient temperature:</b>	0 to 55°C
	<b>Atmospheric humidity:</b>	Maximum 95%, non-condensing
<i>Shock resistance</i>	<b>Sinusoidal vibration:</b>	
	<b>(EN 60068-2-6)</b>	10 to 58 Hz: 0.035 mm 58 to 500 Hz: 0.5 G (~ 5 m/ s <sup>2</sup> )
	<b>Impact:</b>	
	<b>(EN 60068-2-27/ -29)</b>	5 G (~ 50 m/ s <sup>2</sup> ), duration: 30 ms
<i>Protection class</i>	<b>Protection class:</b>	IP20
<i>Power supply</i>	<b>Supply voltage:</b>	22–30V V <sub>DC</sub>
<i>24 V<sub>DC</sub> power pack</i>	<b>Power consumption:</b>	32 W for the basic version
<i>Electromagnetic Compatibility (EMC)</i>	<b>Interference resistance:</b>	according to EN 61000-6-2
	<b>Emitted resistance:</b>	according to EN 61000-6-4
<i>Transport and storage</i>	The same values for atmospheric humidity and shock resistance are to be observed during transport and storage as in operation. The shock resistance during transport can be improved by means of suitably packing the Industrial PC. The ambient temperature during storage and transport must be between -20°C and +65°C.	

## Approvals

### FCC: Federal Communications Commission Radio Frequency Interference Statement

*FCC Approval for USA*

This equipment has been tested and found to comply with the limits for a Class A digital device, pursuant to Part 15 of the FCC Rules. These limits are designed to provide reasonable protection against harmful interference when the equipment is operated in a commercial environment. This equipment generates, uses, and can radiate radio frequency energy and, if not installed and used in accordance with the instruction manual, may cause harmful interference to radio communications. Operation of this equipment in a residential area is likely to cause harmful interference in which case the user will be required to correct the interference at his own expense.

### FCC: Canadian Notice

*FCC Approval for Canada*

This equipment does not exceed the Class A limits for radiated emissions as described in the Radio Interference Regulations of the Canadian Department of Communications.